

PUSH,0/1-10V,100K,PWM 4 in 1 Dimmer Driver



45W

waterproof
Constant Voltage

2 Years Warranty

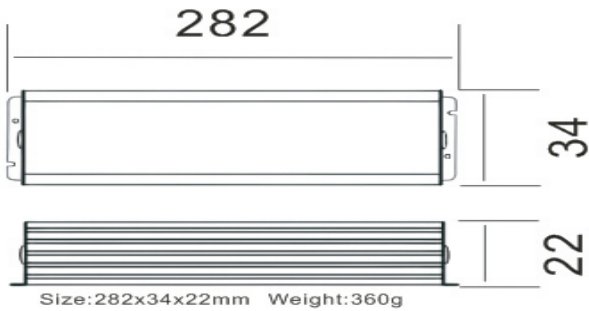

- 工作温度 Operating Temperature: $-20\sim 50^{\circ}\text{C}$
- 储存保护 Storage Temperature: $-40\sim 85^{\circ}\text{C}$
- 湿度 Humidity(Non-Condensing): $5\sim 95\%$
- 散热方式 Cooling : Convection/通风对流
- 百分百满载老化测试 100% full load burn-in test
- 产品仅仅适用于LED模块(LED灯或广告牌等)
- Suitable for LED module (lighting or sign applications)
- 设备不依靠灯具的外壳防护电击
The device can't anti-electricity by the housing
- 由于安全原因,设备只能由合格的技术人员打开
For safety, the device only be opened by qualified specialist
- 电源应由合格的电工按照规范安装,每个负载的电流和输出功率的负荷不得超过指定的标签值。
The device should be installed by the specialist following the guide, each load can not be over the rated data on the label

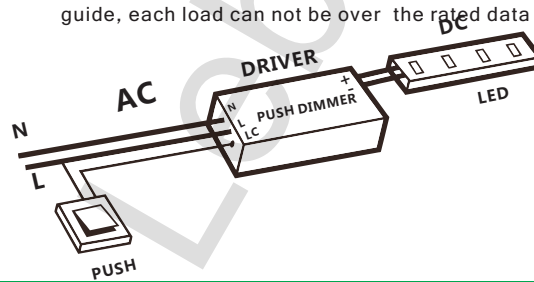

型号/Model	SD-PUSH KAV-12045-O -W	SD-PUSH KAV-24045-O-W
输入电压/Input Voltage(VAC)	90-250V	90-250V
输入频率/Input Frequency(Hz)	50-60Hz	50-60Hz
输出电压/Output Voltage(VDC)	12V \pm 0.5V	24V \pm 0.5V
输出电流/Output Current(A)	3.75A max.	1.86A max.
输出功率/Output Power(W)	When AC 110V Max: 36W / when AC 220V Max: 45W	
工作效率/Work Efficiency(%)	80%	
超载保护/Overload Protection	Yes	
短路保护/Short circuit Protection	Yes	
温度保护/Temperature Protection	Not	
外壳材料/Housing Material	Aluminum white colour	
防护等级/IP Classification	IP 66	
调光信号Dimming signal	PUSH (AC), 0~10V(DC), PWM, 100K {4 in 1}	
调光功能Dimming function	1. Brightness From 100% to 0% 2. The dimming synchronization	
电源线/Cable	Input: H03VV-F 3G*0.75mm ² & (AC PUSH Output0: of Toefl 1C*0.34mm ² Output 1set (DC Output) : of VDE H03VV-F 2G*1mm ² & 1set (Dim Output) : of Toefl 2G*0.34mm ²	
包装/Package:	50 PCS/CTN	
Reference Safety & EMC 安规及电磁相容性参考标准	CE Safety Standard (LVD)	Compliance to EN61347-1:2001;A1 EN61347-2-13:2006
	EMI conduction&radiation 传导/辐射	Compliance to EN55015:2006+A1 EN61547:1995+A1
	EMS Harmonic Current 谐波	Compliance to EN61000-3-2:2006 EN61000-3-3:2008
	Security Classification 安全使用等级	Classification of Installation and Use: Class I